



QUIK DRIVE Auto-Feed Screw System

Delivers the superior holding power of screws and more speed than you ever dreamed possible.

Quik Drive® Auto-Feed Screw Driving Systems

APPLICATIONS: DRYWALL

SIMPSON Strong-Tie

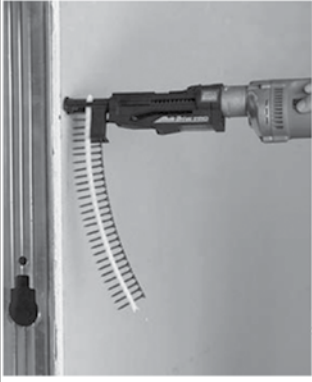

- Recommended for wood and steel framing
- Increases comfort and productivity
- Reduces labor, waste, and expense

Quik Drive® auto-feed screw driving systems are ideal for drywall because our precision countersink adjustment produces consistent dimples and the auto-feed mechanism allows fast, hassle-free driving.



PRO200 System ← 1½" - 2" →

Applications: Drywall, wood underlayment, fiberglass-backed gypsum sheathing

- Compact body for reduced weight and easy handling
- Smooth nose will not mar drywall surface
- Slim profile allows driving in corners
- Details, pg 34



QDA158G2 Attachment ← 1" - 1½" →

Applications: Drywall

- Compact body for reduced weight and easy handling
- Smooth nose will not mar drywall surface
- Slim profile allows driving in corners
- Details, pg 49



2000SDS System ← 1½" - 3" →

Applications: Drywall, subflooring, decks/docks

- Precise self-locking depth adjustment for consistent fastening
- Interchangeable guide tubes for a variety of applications
- Details, pg 45

Quik Drive® Auto-Feed Screw Driving Systems

APPLICATIONS: SUBFLOORING/SHEATHING

SIMPSON Strong-Tie



- Recommended for wood and steel framing
- Fasten 2,000 sq ft in just over an hour
- System warns when screw misses joist

Quik Drive® auto-feed screw driving systems are ideal for subfloor applications because the holding power of screws reduces gaps that cause floor squeaks, and the extension enables stand-up-and-drive subfloor installation.



PRO250 System ← 1½" - 2½" →

Applications: Subfloor/sheathing, fiber-cement siding

- Expanded depth settings for high-density flooring materials
- Uniform toenailing and countersink on slick surfaces
- Reversible and replaceable non-skid teeth attachment
- Details, pg 36



PROCCS/CCS+ Combo System ← 1" - 3" →

Applications: Subfloor/sheathing, wall plates, stair treads, decks/docks, fiber-cement siding











- Expanded depth settings for high-density materials
- Reversible and replaceable non-skid teeth attachment
- Sure-grip guide tube increases stability for a broad range of screws
- Two screw driving attachments for added versatility
- Details, pgs 37 and 38



2000SDS System ← 1½" - 3" →

Applications: Subfloor, decks/docks, drywall

- Interchangeable guide tubes for a variety of applications
- Affordable, mid-grade system – ideal for remodeling
- Easy to master, effortless to use
- Details, pg 45

	 PRO200	 ODA158G2	 2000SDS
DWC SERIES Drywall-to-wood pg 64 	1 1/4", 1 5/8", 2"	1", 1 1/4", 1 5/8"	1 5/8", 2", 2 1/2"
 DWCG SERIES Drywall-to-wood, N2000® coating pg 64 	1 1/4", 1 5/8"	1 1/4", 1 5/8"	1 5/8"
DWCZ SERIES Drywall-to-wood, pg 64 	1 1/4", 1 5/8", 2"	1 1/4", 1 5/8"	1 5/8", 2"
DWF SERIES Drywall-to-steel (33, 27, 18 mils / 20, 22, 25 ga) pg 65 	1 1/4", 1 5/8"	1", 1 1/4", 1 5/8"	1 5/8"
DWFSD SERIES Drywall-to-steel (54, 43 mils / 16, 18 ga) pg 65 	1 1/4", 1 5/8"	1 1/4", 1 5/8"	1 5/8"
DWFZSD SERIES Drywall-to-steel (54, 43 mils / 16, 18 ga) pg 65 	1 1/4"	1 1/4"	N/A
DWHL SERIES Hi-lo threads pg 65 	1 7/8"	NA	1 7/8"

For more information on Quik Drive screw coatings, see page 58.

 This teal arrow indicates products available with additional corrosion protection, making them suitable for use in some corrosive environments and with some preservative-treated woods. For more information on corrosion, see pages 8–9.